

Spherical roller bearings, cylindrical and tapered bore

Principal dimensions			Basic load ratings		Speed ratings		Designation
d	D	B	dynamic C	static C0	Reference speed	Limiting speed	
mm			kN		r/min		
320	540	176	3923	6000	850	1100	* SKF Explorer bearing 23164 CCK/W33 *

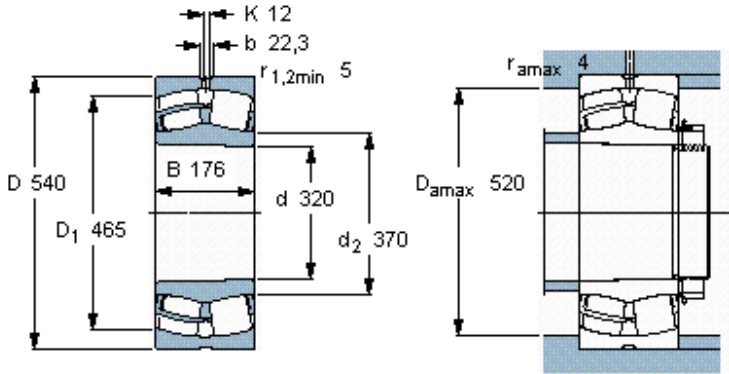

Tapered bore, taper
1: 12

Calculation factors

- e 0,31
- Y_1 2,2
- Y_2 3,3
- Y_0 2,2